

FOS-NIR(1100HT)

PRODUCT SPECIFICATION

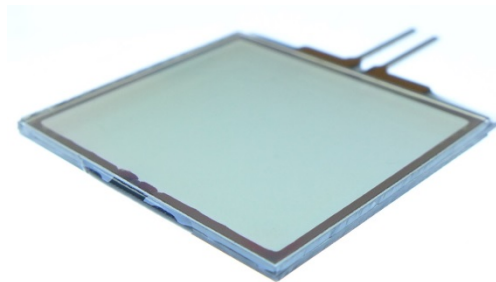

Content

1. Revision history	2
2. Product description	2
3. Ordering information	2
4. Custom designing	2
5. General specifications	3
6. Absolute maximum ratings	3
7. Electro-optical specifications.....	3
8. Graphs	4
9. Drive voltage and recommended controller	7
10. Measurement methods and definitions.....	8
11. Mechanical dimensions	10
12. Electrical connection and wiring diagram	11
13. Handling precautions	12

1. Revision history

<i>Revision</i>	<i>Revision date</i>	<i>Revision content</i>
Initial release	2014-04-08	-
-	-	-

2. Product description

The FOS-NIR(1100HT) (Fast Optical Shutter - Near Infrared Operation) is a polarizer-based nematic liquid crystal (LC) optical shutter that controls the light transmittance by an externally applied drive voltage. It provides broadband visual-near infrared (up to 2,000nm) operation with high open state transmittance optimized for wavelengths around 1,100nm. Compared to conventional mechanical shutters, LC shutters are completely vibration-free and contain no moving parts.

The shutter consists of a polarization modulator in the form of a LC cell positioned between crossed linear polarizers. Applying the drive voltage reorients the birefringent LC molecules, changing the phase retardation of light passing through the LC cell. This results in a change in transmittance of light passing through the full shutter structure. Analogue gray-scale operation between fully open and closed states is realized by voltage amplitude modulation.

3. Ordering information

<i>Product</i>	<i>Part number</i>
13x15_FOS-NIR(1100HT)	LCT-136
1x1_FOS-NIR(1100HT)	LCT-137
2x2_FOS-NIR(1100HT)	LCT-138
D1_FOS-NIR(1100HT)	LCT-140
D2_FOS-NIR(1100HT)	LCT-141
LCC-230 Controller	LCT-030

To purchase or for more information, please contact us at: info@lc-tec.se.

4. Custom designing

Customers not finding their required shutter properties are advised that other FOS models are available and that further optimization and custom designing are possible, both in terms of electro-optical properties and mechanical dimensions (up to 14"x16" size).

Please note that the maximum open state transmittance of the FOS-NIR shutter can be optimized for any given wavelength in the 400 to 2,000nm interval.

5. General specifications

<i>FOS-NIR(1100HT)</i>	
Technology	Nematic LC
Mode of operation	Normally white
Side 1 polarizer transmission axis ¹	+45°
Side 2 polarizer transmission axis ¹	-45°
LC cell substrate material	Polished soda lime glass
Polarizer type and material	Reflective type metal
AR substrate material	N/A
Scratch resistance	N/A

6. Absolute maximum ratings²

<i>FOS-NIR(1100HT)</i>	
Operating temperature ³	-30°C to +70°C
Storage temperature ³	-30°C to +70°C
Drive voltage amplitude	≤24V
Drive voltage frequency	≤1kHz AC square waveform

7. Electro-optical specifications⁴

<i>FOS-NIR(1100HT)</i>	
Open state transmittance ⁵	≥37.0% @ 1,100nm Broadband 400-2,000nm operation, for other wavelengths refer to graphs in section 8.1
Open state color	N/A
Contrast	≥250:1 @ V _D =5V and 1,100nm ≥350:1 @ V _D =24V and 1,100nm Broadband 400-2,000nm operation, for other wavelengths refer to graphs in section 8.1
Angular dependence	Normally or close to normally incident light only recommended
T ₅₀ voltage	1.65V ± 0.2V
Closing time (T ₁₀₀ -T ₁₀)	≤5ms @ V _D =5V ≤120μs @ V _D =24V
Opening time (T ₀ -T ₉₀)	≤15ms @ V _D =5V ≤20ms @ V _D =24V
Reflectance per surface	N/A
Surface quality	N/A
Beam deviation	N/A
RMS average power consumption ⁶	≤6mW
Peak current ⁶	≥20mA

¹ Refer to drawing in section 10.5.

² Reliability tests performed over a range of environmental conditions according to standard IEC 61747-5.

³ Dry, no condensation.

⁴ The specified values are valid for the 1x1 size and measured at room temperature (23°C ± 3°C).

⁵ Refers to unpolarized incident light, the corresponding value for linearly polarized light is typically 75%.

⁶ As measured with f=60Hz, V_D=12V AC square drive waveform with transition slew rate of 3.5V/μs. Actual figures will vary with waveform slew rate, amplitude, frequency, and shutter size. Also see section 9.

8. Graphs (typical values for 1,100nm @ room temperature and $V_D=24V$ unless other specified)

8.1. Open and closed state transmittance vs. wavelength

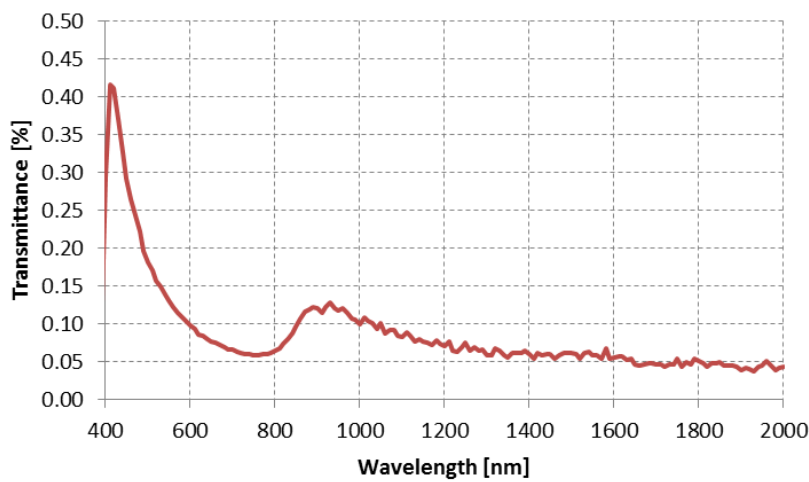
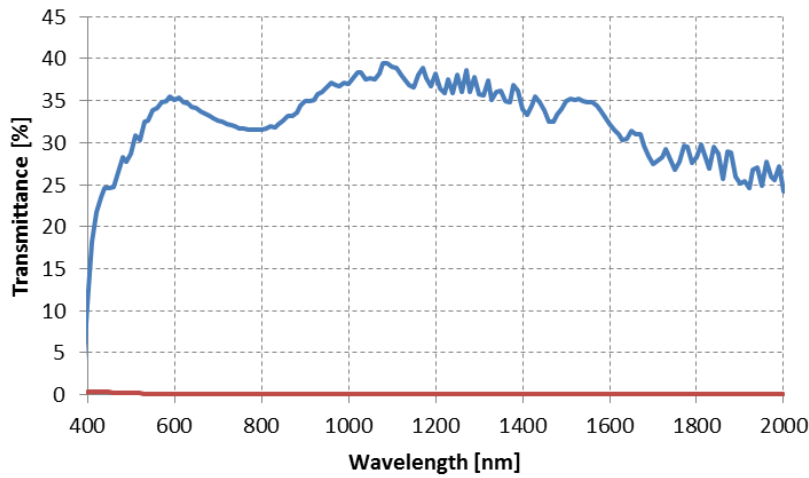

8.2. Transmittance vs. drive voltage amplitude

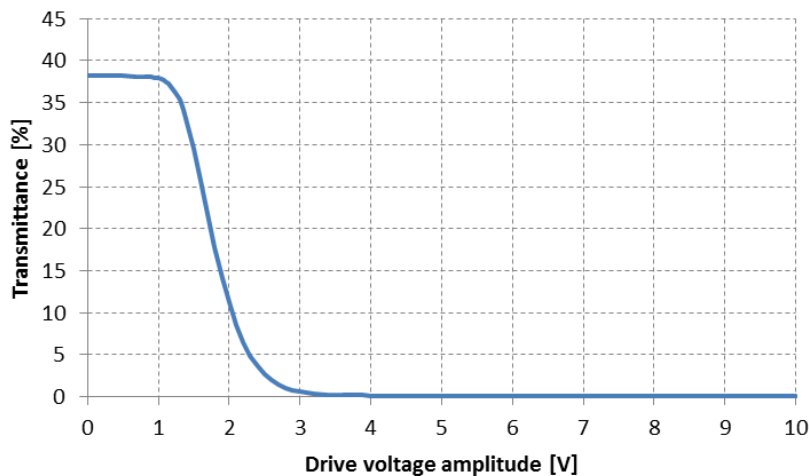

8.3. Closing time at room temperature, normalized transmittance vs. time (drive voltage switched on at t=0)

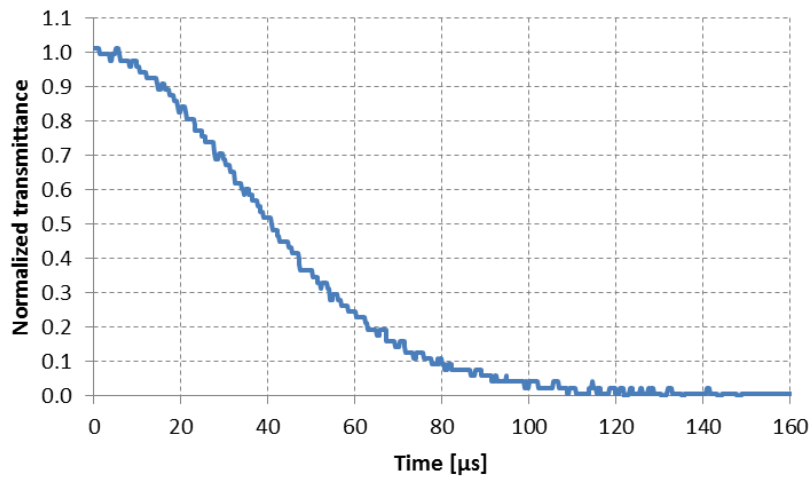

8.4. Closing time vs. temperature

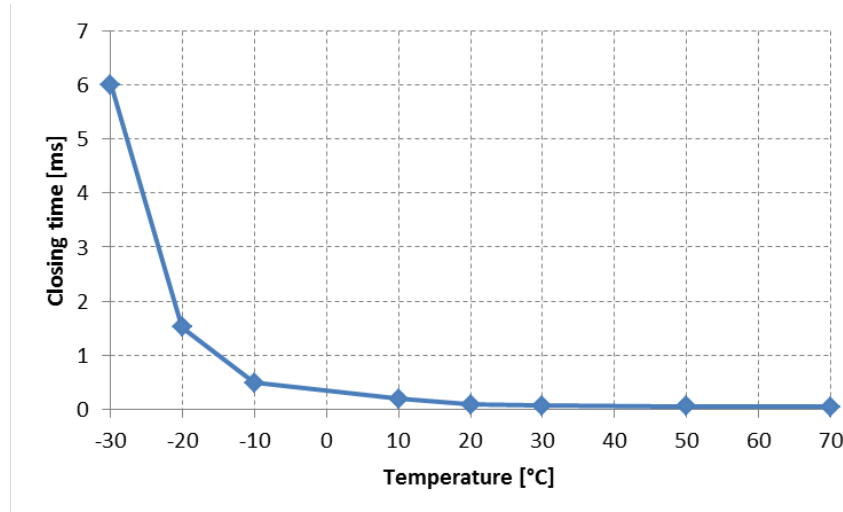

8.5. Opening time at room temperature (for 550nm light), normalized transmittance vs. time (drive voltage switched off at t=0)

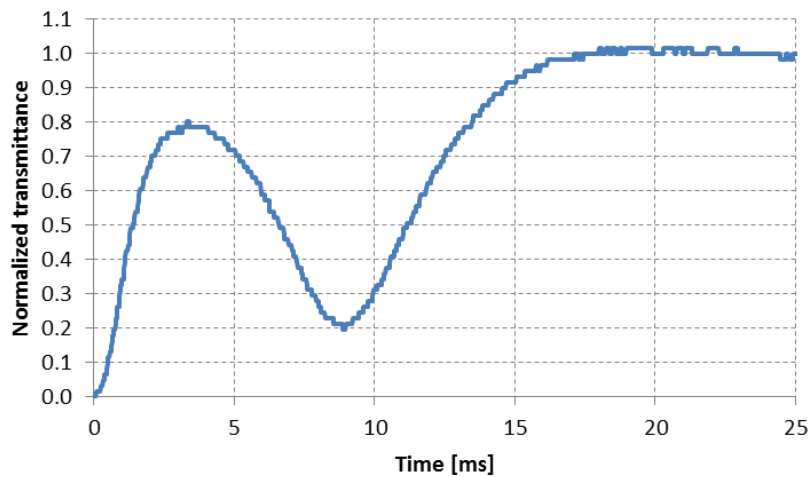

8.6. Opening time vs. temperature

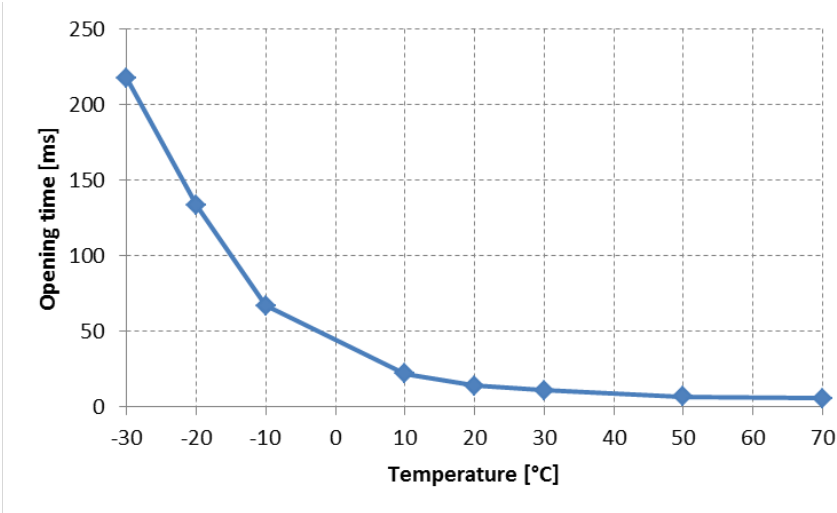

9. Drive voltage and recommended controller

The shutter possesses mono-stable normally white operation, meaning that without voltage applied the shutter is in its fully open, light-transmitting state. Applying the drive voltage, V_D , switches it to a closed, light-absorbing state. This voltage must be kept throughout the duration of the time the shutter is required to be in the closed state. In general, increasing the drive voltage amplitude increases the contrast and shortens the closing time.

The transmittance of the shutter reacts to the RMS voltage. In order to prevent ion migration within the LC layer that might impair shutter performance and lifetime, it is recommended to ensure that there is no net DC bias present in the drive signal. This is best achieved via use of one of the two AC square waveforms illustrated below. When the top one is used, the recommended minimum frequency is 60Hz if visual flicker is to be avoided. The bottom option is suitable when cycled operation between open and closed states is desired.

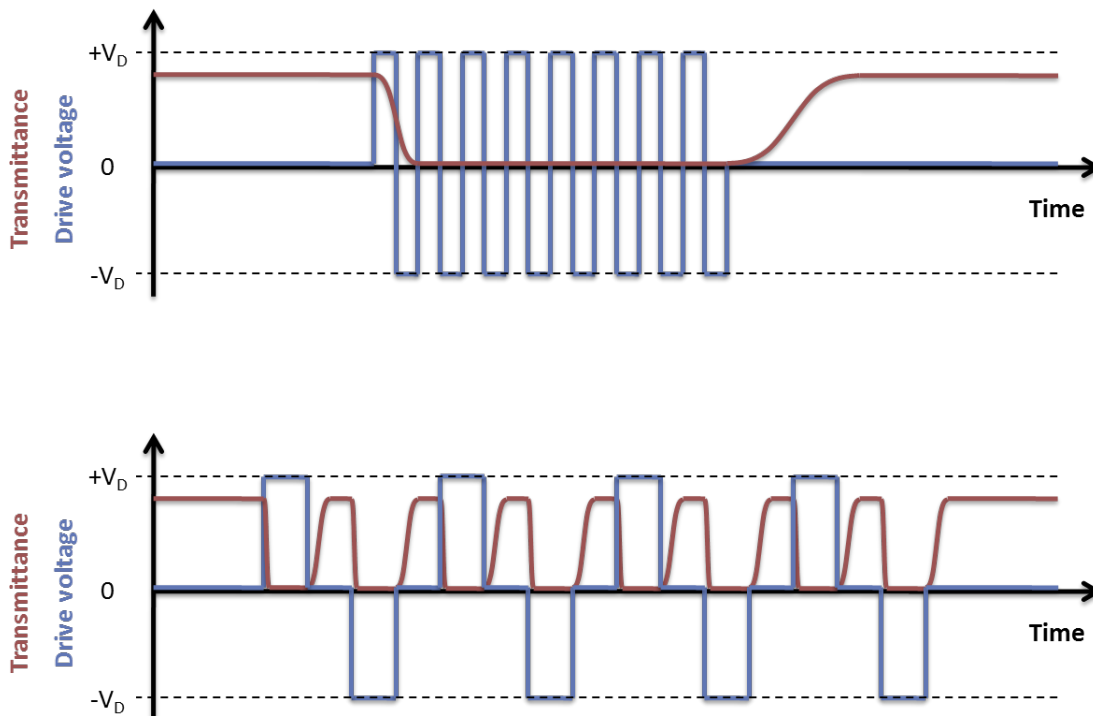

The LCC-230 (*LC-Tec Part number LCT-030*) is a flexible, full-featured liquid crystal controller specifically designed to drive all FOS, X-FOS, and PolarSpeed® models. The LCC-230 incorporates two independent LC channels, each with $30V_{RMS}$ of range and fully short-circuit protected. The controller is operated by the LCDriver2 application via a full-speed USB 2.0 compliant interface. LCDriver2 permits dynamic editing of programs up to 96 lines in length. Three trigger modes (internal, line, program) determine how program lines are executed. Up to nine programs may also be pre-stored on the LCC-230 for stand-alone operation. See user manual for further information.

Note: Customer-developed LC drive stages must be able to deliver at least the peak current of the specific FOS device to be driven. Output-stage ballast capacitors with a maximum ripple current rating at least three times the peak current is recommended.

10. Measurement methods and definitions

10.1. Transmittance, color and contrast

The transmittance is defined as the luminous transmittance of collimated unpolarized light passing perpendicularly through the shutter according to:

$$T = \frac{\int_{380}^{780} T(\lambda)D(\lambda)P(\lambda)d\lambda}{\int_{380}^{780} D(\lambda)P(\lambda)d\lambda}$$

where $T(\lambda)$ is the transmittance function of the shutter, $D(\lambda)$ is the illuminant spectral distribution, and $P(\lambda)$ is the photopic response of the human eye. All transmittance values specified are based on the standard illuminant CIE E (equal-energy for all wavelengths). The corresponding color is mathematically described using the color matching functions of the CIE 1931 Standard Colorimetric Observer, and is represented by a point in the u',v' chromaticity coordinate system.

The contrast is defined as the ratio of the transmittance of the open field-off state to that of the closed field-on state according to:

$$C = \frac{T_{open}(V=0)}{T_{closed}(V=V_D)}$$

Since the transmittance depends on applied drive voltage, also the contrast is a function of the voltage and usually increases with increasing amplitude.

10.2. Angular dependence

The transmittance is not only a function of light wavelength and applied drive voltage. Since the phase retardation induced by the LC cell also depends on the angle between the direction of light and the long axis of the LC molecules, the transmittance of the shutter can for a given angle of incidence be described by:

$$T = T(\theta, \phi, \lambda, V_D)$$

where θ is the polar angle between the light exit direction and the normal vector to the surface, and ϕ is the azimuth angle of the light exit direction as specified below.

The angular dependence of the contrast between the open and closed states in diffuse light is illustrated in a so-called polar plot as shown below. Iso-contrast lines describe the contrast values at various angles. The center of the plot corresponds to light exiting perpendicularly from the shutter surface.

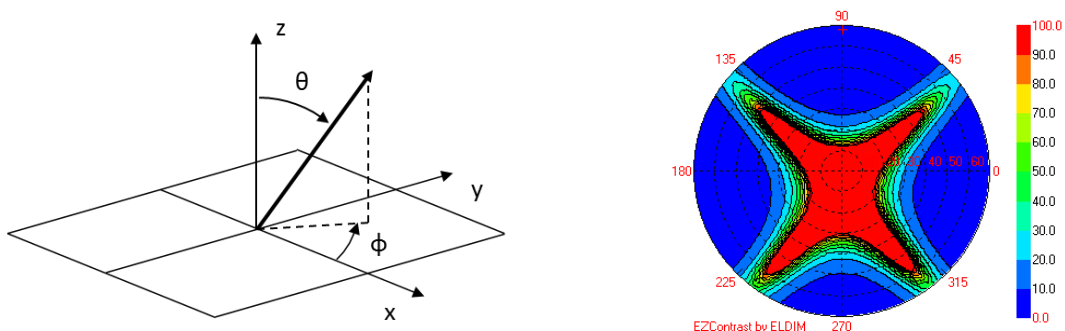

10.3. T_{50} voltage

The T_{50} voltage represents the point on the transmittance vs. applied drive voltage curve where the shutter is switched midway between closed and open states, i.e. the voltage that corresponds to a transmittance level of 50% of the normalized open state transmittance.

10.4. Switching times

Two switching times are associated with the shutter. The time for closing the shutter, closing time (also called the response time or t_{on} time), is defined as the time it takes for the shutter to switch from 100% to 10% ($T_{100}-T_{10}$) of its static open transmittance after the drive voltage is applied. The closing time usually decreases with increasing drive voltage amplitude and increasing temperature.

The corresponding time for opening the shutter, opening time (also called the relaxation time or t_{off} time), is defined as the time it takes for the shutter to switch from 0% to 90% (T_0-T_{90}) of its static open transmittance after the drive voltage is switched off. The opening time is less dependent of the drive voltage amplitude, but decreases with increasing temperature.

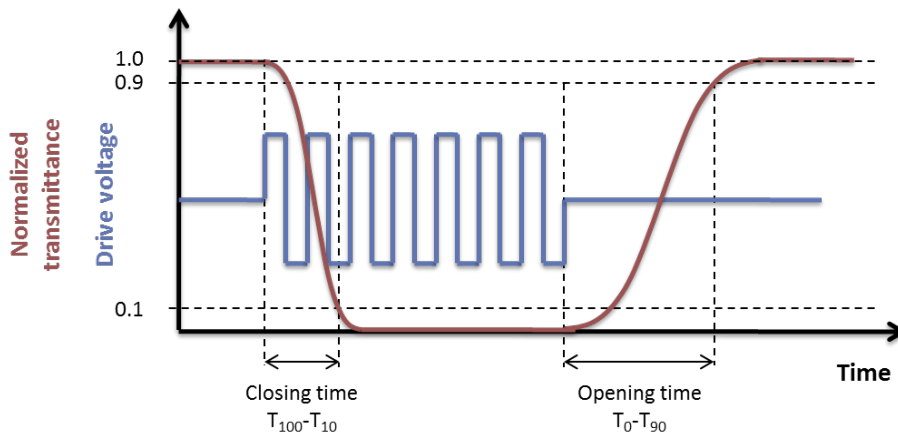

10.5. Polarizer transmission axis

FOS-NIR (1100HT)

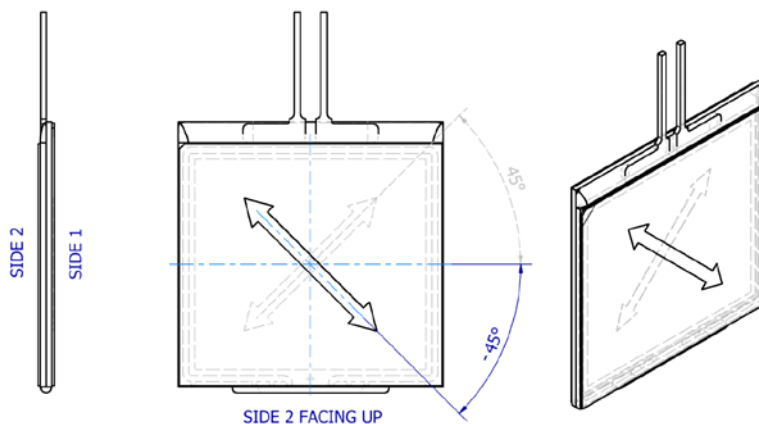

11. Mechanical dimensions⁷

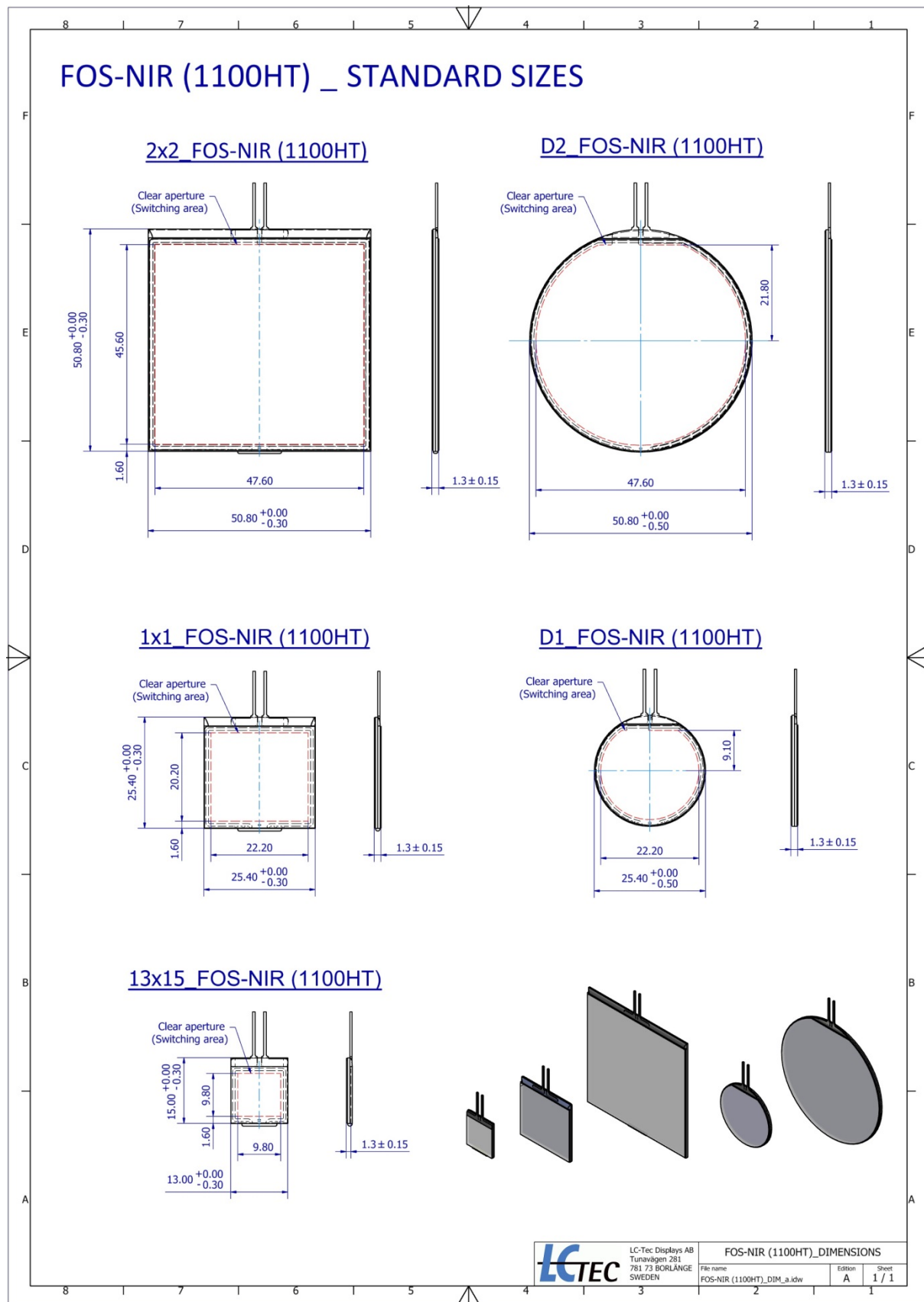

⁷ Refers to available standard sizes. Custom designing up to 14" x 16" size is offered.

12. Electrical connection and wiring diagram

The shutter is supplied with contact pins as illustrated in the drawing below. The desired drive waveform should be applied to the LC cell as indicated in the wiring diagram. The pin design is compatible with 2.54mm pitch connectors (for example the *Molex Part Number 90123-0102*). Customers can also solder wires to the pins or connect them directly to a dedicated PCB (printed circuit board) if desired.

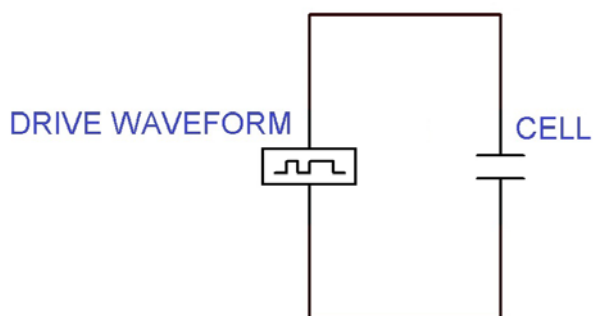
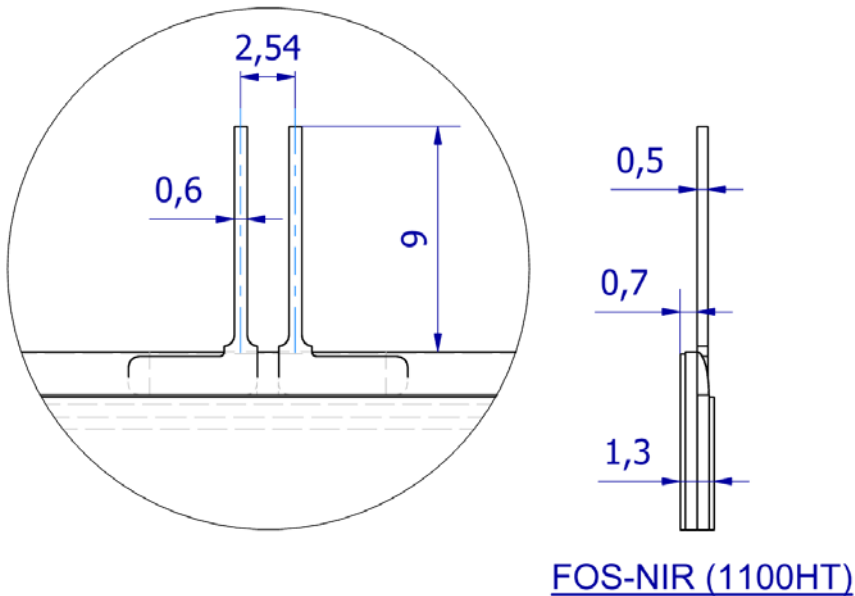

13. Handling precautions

The following provides recommendations for handling of this product.

LC shutter handling and cleaning precautions

- A protective film is supplied on both sides of the shutter and should be left in place until the shutter is required for operation.
- The polarizers do not have any hard-coating on the outer surface, please guard against scratching, do not rub with abrasives.
- Keep the shutter surface clean. Do not touch without protective gloves.
- Should the surface become contaminated, wipe lightly with a soft cloth moistened with solvent (isopropyl alcohol or ethyl alcohol) in order to clean the shutter surface.
- Do not wipe the shutter surface with dry or hard materials that may damage the surface. Do not use the following solvents for cleaning: water, aromatics, acetone or other ketone.
- Since this shutter contains glass substrates, avoid applying mechanical shock or pressure. Do not drop, bend, twist or press on the shutter.

Storage

- Avoid exposure to direct sunlight or high temperature and humidity. Recommended storage conditions: temperature range +5°C to +45°C with humidity <60%RH.
- Do not store the shutter near organic solvents or corrosive gases.
- Keep the shutter protected from vibration, shock and pressure.

Operating precautions

- It is important to operate the shutter within the specified voltage limits; higher voltages may significantly reduce the lifetime of the shutter.
- The use of direct current drive (DC voltage) should be avoided since a reaction stimulated by such current significantly reduces the lifetime of the shutter.
- The switching speed of the shutter will be reduced at lower temperatures, and the optical-shutter will show a dark color at higher temperatures. However, the shutter will revert to normal operation once the temperature conditions return to the range for normal operation.

Safety

- Should the shutter become damaged and the skin is exposed to liquid crystal material, it is recommended to immediately wash off the liquid crystal material using soap and water.
- If the liquid crystal material should come into contact with the eye, flush the eye using running water for at least five minutes. Seek medical advice.
- The polarizers are of reflective type. In the open state approximately half of the incident light is reflected back, while almost all of the light is reflected back in the closed state.